

# Lead2passExam

> Contact Us    Login / Register    Search...

Lead2passExam

HOME

ALL VENDORS

★ GUARANTEE

? FAQ

TESTIMONIALS

CART (1)

## Pass Your Next Certification Exam Fast!

Everything you need to prepare, learn & pass your certification exam easily.  
365 days free updates. First attempt guaranteed success.



Select a vendor...

Select an test...

Your email address

Free Download Demo

### Top Certifications

- ▶ IBM Cognos   ▶ Linux Essentials   ▶ Magento Certified Developer Plus   ▶ BCS Certification
- ▶ Citrix NetScaler   ▶ Nokia Networks Certification   ▶ Solutions Expert
- ▶ VCAP6-DCV Deployment   ▶ Oracle Sales Cloud 2016 Certified   ▶ Oracle Service Cloud
- ▶ CCP-N   ▶ IBM Certified Mobile System Administrator   ▶ Windows 7   ▶ APC Certification
- ▶ HPE Sales Certified

### Top Vendors

- ▶ Logical Operations   ▶ TIA   ▶ Pegasystems   ▶ IISFA   ▶ Mile2   ▶ 3COM   ▶ Altiris   ▶ IIA
- ▶ AccessData   ▶ Avaya   ▶ BACB   ▶ Nokia   ▶ RAPS   ▶ McAfee   ▶ Professional Tests
- ▶ Mile2-Security   ▶ CIPS   ▶ Legato   ▶ ASQ   ▶ QlikView   ▶ NSCA   ▶ PSAT   ▶ HRCI
- ▶ WorldatWork   ▶ Guidance Software

### What Client's Say

“ Passed the exam yesterday, but 10 questions new not came from this dump. every other questions are same. Totally valid. ”



Roy  
★★★★★

“ This is still valid. Passed today with 80%. looked like 3-4 new questions. Many thanks! Good braindumps ”



Vic  
★★★★★

<http://www.lead2passexam.com/>

Available Exam Cram and Valid Dumps - Lead2Pass Exam

**Exam** : **200-901J**

**Title** : **DevNet Associate Exam  
(200-901日本語版)**

**Vendor** : **Cisco**

**Version** : **DEMO**

**QUESTION NO: 1**

開発者は、Dockerビルドで使用する新しいイメージを作成し、次のコマンドを使用してイメージのタグを追加しました。

```
$ docker tag 84fe411926287 local / app : 0.4
```

タグを使用してDockerイメージをビルドするには、次にどのコマンドを実行する必要がありますか？

A. \$ docker build -p local / app : 0.4

B. \$ docker run -t local / app : 0.4

C. \$ docker run -p local / app : 0.4

D. \$ docker build -t local / app : 0.4

**Answer: D**

Explanation:

The docker build command is used to build an image from a Dockerfile. The -t option tags the image with a specified name and tag.

Tagging: The docker tag command associates an image ID with a repository and tag.

Building with Tag: The correct command to build the Docker image and tag it as local/app:0.4 is docker build -t local/app:0.4.

Option D is the correct command to build and tag the image.

Reference:

Docker Documentation: Docker Build Reference

**QUESTION NO: 2**

ネットワーク エンジニアが Cisco Prime に複数の API

呼び出しを行い、すべてのデバイスのリストを取得します。応答が受信されるたびに、デバイスのサブセットのみが返されます。エンジニアは、一部の API 呼び出しで HTTP コード 200 ではなく 429

が返されることに気付きました。応答で一部のデバイスが除外されるのはなぜですか。

A. API はリクエストで示されたオフセットを適用しました。

B. API は取得するアイテムの数を識別できませんでした。

C. API がリクエストをタイムアウトしました。

D. APIレートがリクエストを制限しました

**Answer: D**

Explanation:

HTTP status code 429 indicates that too many requests have been sent in a given amount of time, which is a sign of rate limiting. Rate limiting is used by APIs to control the amount of incoming requests to prevent abuse or overloading the server. In this case, the Cisco Prime API is limiting the number of requests the network engineer can make in a certain time period, resulting in only a subset of devices being returned and some requests being rejected with a 429 status code.

Reference:

Cisco DevNet Associate Certification Guide

HTTP Status Code Definitions

**QUESTION NO: 3**

展示品を参照してください。

```
$ find /home/user/backup -mtime +30 -type f -print
$ find /home/user/backup -mtime +30 -type f -delete
```

あるエンジニアが企業のネットワークを管理しています。ネットワークは分散導入モデルを採用しており、ログの保存にはデータベースを使用しています。現在のポリシーでは、データセンター内のいずれかのデバイスのインフラストラクチャに変更が加えられた場合、ログを保存することが義務付けられています。Bashスクリプトによって自動化されているワークフローはどれですか？

- A. 30日以上前のバックアップファイルを返します
- B. 30日以上経過したバックアップファイルを削除します
- C. ファイルを自動的に削除するようにディレクトリを構成する
- D. 30日ごとにすべてのバックアップファイルを自動削除する

**Answer: B**

Explanation:

The Bash script provided in the exhibit performs two find commands:

find /home/user/backup -mtime +30 -type f -print: This command searches for files in the /home/user/backup directory that have been modified more than 30 days ago and prints their names.

find /home/user/backup -mtime +30 -type f -delete: This command searches for files in the /home/user/backup directory that have been modified more than 30 days ago and deletes them.

Thus, the workflow being automated by this Bash script is the deletion of backup files that are older than 30 days.

Reference:

GNU find Documentation

Cisco DevNet Associate Certification Guide

#### QUESTION NO: 4

企業のいくつかのチームは、顧客満足度を向上させ、収益を増やすことを目的として、顧客とのやり取りを追跡するための新しいCRMソリューションを開発しています。提案されたソリューションには、次のコンポーネントが含まれています。

\*顧客に関するデータを保存するMySQLデータベース

\* Apacheで実行されるHTML5およびJavaScriptUI

\* Pythonで記述されたRESTAPI

ソリューションの開発にMVCデザインパターンを適用することの2つの利点は何ですか？  
(2つ選択してください。)

- A. 同じデータの複数のビューを異なるユーザーグループに表示できるようにする
- B. すべてのロジックがコントローラーに分離されるようにすることで、ビューとモデルを分離します
- C. データの一貫性を確保するため。ビューへの変更もモデルに加える必要があります
- D. データモデルのインスタンスを1つだけ作成できるようにする
- E. 一貫性を確保するためにデータの単一のビューのみを提供する

**Answer: B,A**

**Explanation:**

The Model-View-Controller (MVC) design pattern provides several advantages, including the ability to present multiple views of the same data to different user groups and the separation of concerns by dividing the application into three interconnected components.

A . to enable multiple views of the same data to be presented to different groups of users - Correct. MVC allows different views to display the same data, enhancing flexibility and usability. B. to provide separation between the view and the model by ensuring that all logic is separated out into the controller - Correct. MVC promotes the separation of concerns, making the application easier to manage and scale. C. to ensure data consistency, which requires that changes to the view are also made to the model - Incorrect. This is not a primary advantage of MVC; changes to the view do not directly affect the model. D. to ensure that only one instance of the data model can be created - Incorrect. This is not a characteristic or advantage of MVC. E. to provide only a single view of the data to ensure consistency - Incorrect. MVC supports multiple views.

**Reference:**

MVC Design Pattern

**QUESTION NO: 5**

展示品を参照してください。

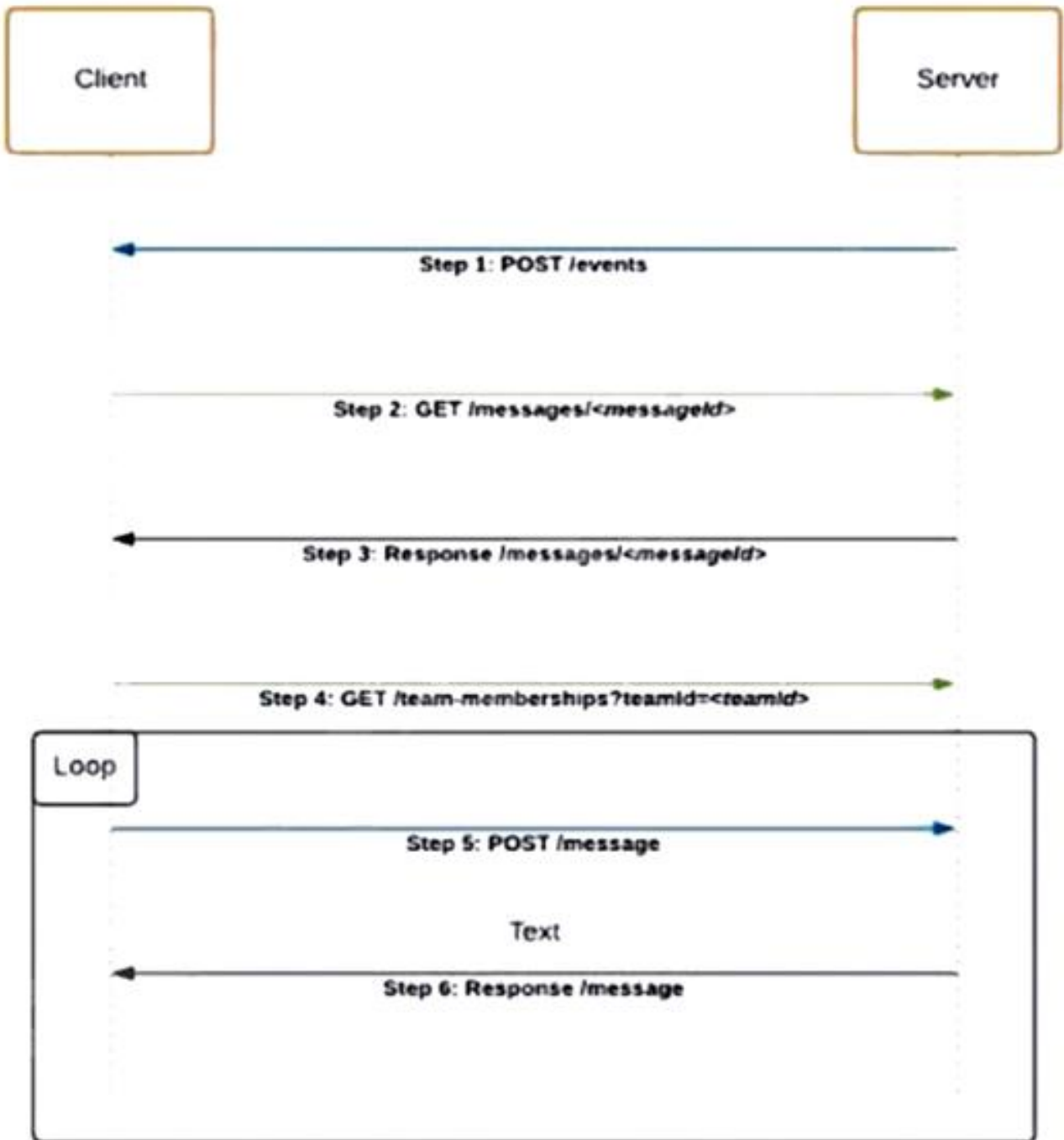

シーケンスを表すコード スニペット。

A.

```
@flask_app.route('/events', methods=['POST'])
def webex_teams_webhook_events():
    json_data = request.json['data']
    response = requests.get(MESSAGE_URL +
    json_data['id'], headers=headers)
    if response.json()['text'] == 'Alert':
        response = requests.get(Team_MEMBERSHIPS_URL,
        headers=headers, params=params)
        for info in response.json()['items']:
            data = {'personId': info['personId'], 'text':
            'Alert'}
            response = requests.post(MESSAGES_URL,
            headers=headers, params=params)
```

B.

```
@flask_app.route('/events', methods=['POST'])
def webex_teams_webhook_events():
    json_data = request.json['data']
    if response.json()['text'] == 'Alert':
        response = requests.get(MESSAGE_URL +
    json_data['id'], headers=headers)
        response = requests.get(Team_MEMBERSHIPS_URL,
        headers=headers, params=params)
        for info in response.json()['items']:
            data = {'personId': info['personId'],
            'text': 'Alert'}
            response = requests.post(MESSAGES_URL,
            headers=headers, params=params)
```

C.

```
@flask_app.route('/events', methods=['POST'])
def webex_teams_webhook_events():
    json_data = request.json['data']
    response = requests.post(MESSAGE_URL +
    json_data['id'], headers=headers)
    if response.json()['text'] == 'Alert':
        for info in response.json()['items']:
            response = requests.get(Team_MEMBERSHIPS_URL,
            headers=headers, params=params)
            data = {'personId': info['personId'], 'text':
            'Alert'}
            response = requests.get(MESSAGES_URL,
            headers=headers, params=params)
```

D.

```
@flask_app.route('/events', methods=['POST'])
def webex_teams_webhook_events():
    json_data = request.json['data']
    response = requests.get(Team_MEMBERSHIPS_URL,
    headers=headers, params=params)
    if response.json()['text'] == 'Alert':
        response = requests.get(MESSAGE_URL +
    json_data['id'], headers=headers)
        for info in response.json()['items']:
            data = {'personId': info['personId'], 'text':
            'Alert'}
            response = requests.post(MESSAGES_URL,
            headers=headers, params=params)
```

**Answer: C**

Explanation:

Refer to the exhibit which shows a sequence diagram illustrating a client-server interaction.

The correct sequence of steps that match the code snippet is as follows:

Step 1: POST /events - The client posts an event to the server.

Step 2: GET /messages/<messageId> - The client retrieves the message details from the server using the message ID.

Step 3: Response /messages/<messageId> - The server responds with the message details.

Step 4: GET /team-memberships?teamId=<teamId> - The client retrieves team membership

details using the team ID.

Step 5: POST /message - The client posts a message.

Step 6: Response /message - The server responds with the message confirmation.

The correct code snippet represents the sequence diagram correctly:

```
@flask_app.route('/events', methods=['POST'])
def webex_teams_webhook_events():
    json_data = request.json['data']
    response = requests.get(MESSAGE_URL + json_data['id'], headers=headers)
    if response.json()['text'] == 'Alert':
        response = requests.get(Team_MEMBERSHIPS_URL, headers=headers, params=params)
    for info in response.json()['items']:
        data = {'personId': info['personId'], 'text': 'Alert'}
```

### QUESTION NO: 6

YAMLとJSONのデータ構造の違いは何ですか？

- A. YAMLはスペースを使用します。JSONは括弧を使用します
- B. YAMLはインデントを使用します。JSONは角かっこ中かっこを使用します
- C. YAMLは角かっこ中かっこを使用します。JSONはインデントを使用します
- D. YAMLは括弧を使用します。JSONはスペースを使用します

**Answer:** B

Explanation:

The difference between YAML and JSON in terms of data structure representation is that YAML uses indentation to indicate structure, while JSON uses brackets and braces.

A . YAML uses spaces; JSON uses parentheses - Incorrect. JSON does not use parentheses.

B. YAML uses indentation; JSON uses brackets and braces - Correct. YAML relies on indentation for structure, whereas JSON uses brackets and braces. C. YAML uses brackets and braces; JSON uses indentation - Incorrect. This is the opposite of the correct statement.

D. YAML uses parentheses; JSON uses spaces - Incorrect. Neither format uses these exclusively.

Reference:

YAML vs. JSON

### QUESTION NO: 7

## Devices

## Get Device Count

**Operation Id:** *getDeviceCount***Description:** *Returns the count of network devices based on the filter criteria by management IP address, mac address, hostname and location name***GET** /dna/intent/api/v1/network-device/count

## Request Parameters

## Responses

**Status:** 200*The request was successful. The result is contained in the response body.*Schema Definition

## Example Body

```

- CountResult
  - response: integer
  - version: string

```

+ -

展示を参照してください。下部のコード スニペットをコード内の空白にドラッグ アンド ドロップして、Cisco DNA Center スイッチ数を検索するリクエストを作成します。すべてのオプションが使用されるわけではありません。

```

curl -L --request [ ] \
-- [ ] https://dna/intent/api/v1/network-device/[ ] \
--header '[ ] : application/json' \
--header 'Accept: application/json'

```

url

network

count

POST

GET

Content-Type

**Answer:**

```
curl -L --request GET \
--url https://dna/intent/api/v1/network-device/count \
--header 'Content-Type: application/json' \
--header 'Accept: application/json'
```

url	network	count
POST	GET	Content-Type

**QUESTION NO: 8**

展示を参照してください。

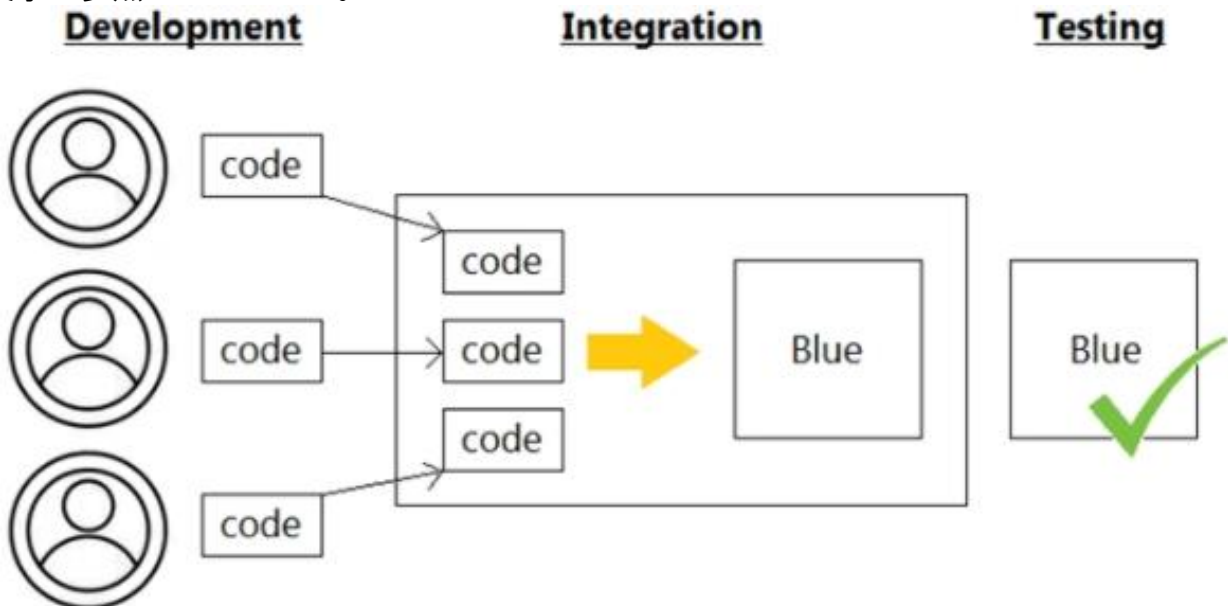

どのインフラストラクチャ自動化方法が表示されますか？

- A. Waterfall
- B. CI/CD pipeline
- C. Agile
- D. Lean

**Answer:** D

Explanation:

The exhibit illustrates a Continuous Integration/Continuous Deployment (CI/CD) pipeline. This method involves continuous integration of code from multiple developers, automated testing, and continuous delivery/deployment to production. It ensures that code changes are automatically built, tested, and deployed, promoting efficient and reliable software development practices.

**QUESTION NO: 9**

企業は、内部変革の一環としてDevOpsを採用しており、最初の展開の成功を検討しています。開発者とエンジニアは、結果として生じる問題を解決するために協力しています。ただし、この新しい作業方法はオーバーヘッドを増加させ、チームはリリースを時間内に完了するのが難しいと感じています。

CALMSフレームワークのどの領域を改善の対象にする必要がありますか？

- A. コラボレーション
- B. リーン
- C. 共有
- D. 測定

**Answer:** B

Explanation:

The CALMS framework is used to assess and guide DevOps transformations. It stands for Culture, Automation, Lean, Measurement, and Sharing. Each element represents a critical area for improvement in DevOps practices.

Collaboration: Emphasizes teamwork and breaking down silos.

Lean: Focuses on eliminating waste, optimizing processes, and ensuring efficiency.

Sharing: Encourages transparency and knowledge sharing among teams.

Measurement: Involves monitoring and analyzing performance metrics to drive improvement.

Given that the team is struggling to complete releases on time due to increased overhead, targeting the Lean aspect can help streamline processes, reduce waste, and improve efficiency, ultimately helping them to meet their release deadlines.

Reference:

Cisco DevNet DevOps Essentials: CALMS Framework

#### QUESTION NO: 10

Meraki APIでサポートされている2つのユースケースはどれですか？

(2つ選択してください。)

- A. Merakiカメラからライブストリームを取得します。
- B. モバイルアプリ用のカスタムキャプティブポータルを構築します。
- C. ダッシュボードAPIを介してネットワークデバイスを構成します。
- D. Wi-FiおよびLoRaWANデバイスから位置認識アプリを構築します。
- E. アプリケーションをデバイスに展開します。

**Answer:** A,C

Explanation:

Meraki APIs offer various functionalities, including:

Retrieve live streams from a Meraki Camera (A): Meraki provides API endpoints to access live video streams from its cameras, enabling integration with custom applications.

Configure network devices via the Dashboard API (C): The Meraki Dashboard API allows for comprehensive configuration and management of Meraki network devices.

Reference:

Cisco Meraki API Documentation (details on the capabilities of Meraki APIs) Cisco DevNet Associate Exam Topics: APIs and Automation (understanding how to use APIs for network configuration and monitoring)

#### QUESTION NO: 11

展示を参照してください。

```
git clone git://git.kernel.org/.../git.git my.git
cd my.git
git branch -d -r origin/todo origin/html origin/man (1)
git branch -D test (2)
```

(2) とマークされたコマンドは、実行すると何を行いますか？

- A. 「テスト」ブランチを複製します。
- B. 新しいブランチが作成された場合にのみ、「test」ブランチを削除します。
- C. 「test」ブランチを削除します。
- D. マージされるまでブランチは削除されません。

**Answer:** C

Explanation:

The command `git branch -D test` forcefully deletes the local branch named `test`, even if it has unmerged changes.

Deleting Branches: `git branch -D` is used to delete a branch forcefully.

Force Deletion: The `-D` flag forcefully deletes the branch regardless of its merge status.

Option C correctly describes the action of the command, which is to delete the `test` branch.

Reference:

Git Documentation: Git Branch Command

#### QUESTION NO: 12

展示を参照してください。

```
#!/bin/bash
<item 1>='date +%b-%d-%y'

<item 2>=/home/usr/path/backup-$BACKUPTIME.tar.gz

<item 3>=/home/usr/path/data_folder

tar -cpzf $DESTINATION $SOURCEFOLDER
```

左側の変数を、展示内の欠落している割り当てに一致する右側の項目番号にドラッグアンドドロップします。

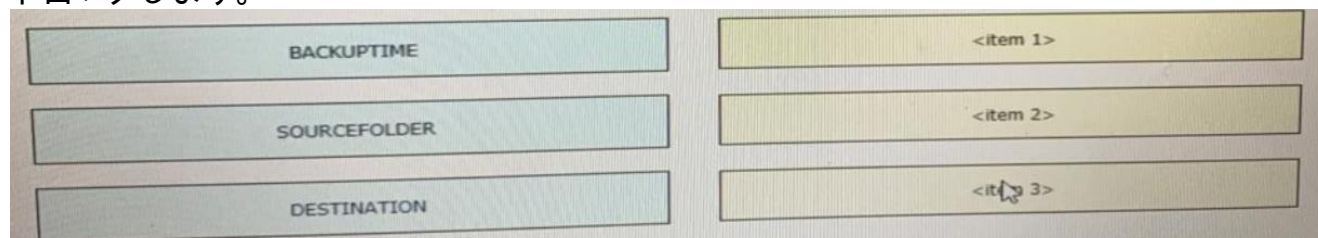

**Answer:**

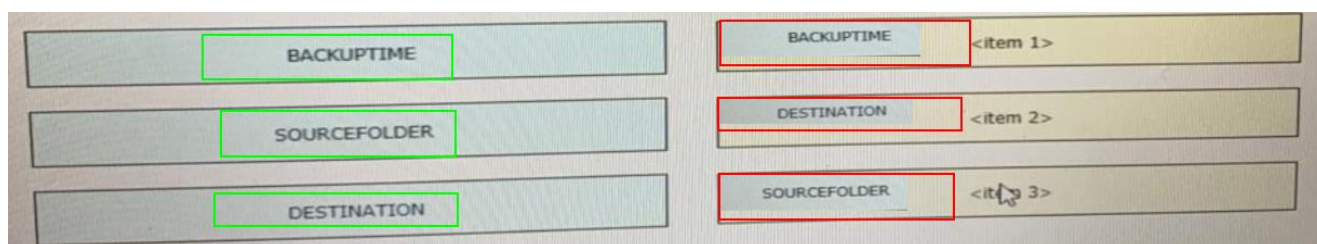
**QUESTION NO: 13**

展示を参照してください。

```

1  - hosts: servers
2      tasks:
3
4      - name: task1
5          systemd:
6              name: webexbot
7              state: stopped
8
9      - name: task2
10         apt:
11             name: teamsbot
12
13     - name: task3
14         apt:
15             name: webexbot
16             state: absent
17             purge: yes

```

開発者は、ポットを社内通信アプリに統合する必要があります。開発者は、Ansibleを使用して webexbot パッケージを teamsbot パッケージに置き換え、プレイブックを準備したいと考えています。最初の 2 つのタスクでは、プレイブックは webexbot を停止し、teamsbot がインストールされていることを確認します。開発者が Ansible プレイブックを実行すると、ワークフローの最後のタスクで何が達成されますか？

A. webexbot サービスを停止し、アンインストールして構成ファイルを保持します。

B. webexbot をインストールし、設定ファイルを保持します

C. webexbot パッケージをアンインストールし、その構成ファイルを削除します。

D. リポジトリ内でパージパッケージが利用可能かどうかを検索し、webexbot パッケージをアンインストールします。

**Answer: C**

Explanation:

In the Ansible playbook, the last task uses the apt module with state: absent and purge: yes for the webexbot package. This configuration ensures that the package is uninstalled and all associated configuration files are removed. This is different from a simple uninstall, which would leave configuration files behind.

Reference:

Cisco DevNet Associate Study Guide: Automation with Ansible (Chapter 7, Section: Ansible Playbook Examples and Syntax).

**QUESTION NO: 14**

インフラストラクチャ自動化のためのモデル駆動型アプローチの利点は何ですか？

- A. モデリング環境を通じてすべての自動化スクリプトの生成を強制します
- B. 小さな学習曲線を提供し、コーディング経験が限られているシステム管理者を支援します
- C. システム管理者がコーディングを十分に理解し、経験と機能を拡張できるようにします
- D. ユーザーが宣言型言語を理解して、モデルを実用的なスクリプトに翻訳できるようにします

**Answer:** B

Explanation:

A model-driven approach for infrastructure automation offers several benefits. One of the primary advantages is that it provides a small learning curve and helps system administrators with limited coding experience. By using high-level models and declarative languages, administrators can define the desired state of the infrastructure without needing to write complex scripts.

Declarative Language: Model-driven approaches use declarative languages that allow users to specify what the desired state should be, rather than how to achieve that state. This abstracts the complexity of the underlying automation processes.

**QUESTION NO: 15**

```
user@host1:~/tmp$ cat Dockerfile
# Dockerfile to install traceroute
FROM ubuntu
MAINTAINER User One (userone@cisco.com)
RUN apt-get update && apt-get install traceroute
```

展示を参照してください。左側の Dockerfile の内容を右側の関数にドラッグアンドドロップして、特定のターゲットへのネットワークパスを追跡する traceroute を実行するコンテナ

イメージを作成します。すべてのオプションが使用されるわけではありません。

document author

FROM ubuntu

command to execute

MAINTAINER User One (userone@cisco.com)

initializes a new build stage

RUN apt-get update && apt-get install traceroute

copies new files or directories

sets the userid

**Answer:**



**QUESTION NO: 16**

変更されたローカルファイルをリモートリポジトリに追加するGITコマンドを左から右にドラッグアンドドロップします。すべてのオプションが使用されるわけではありません。



**Answer:**

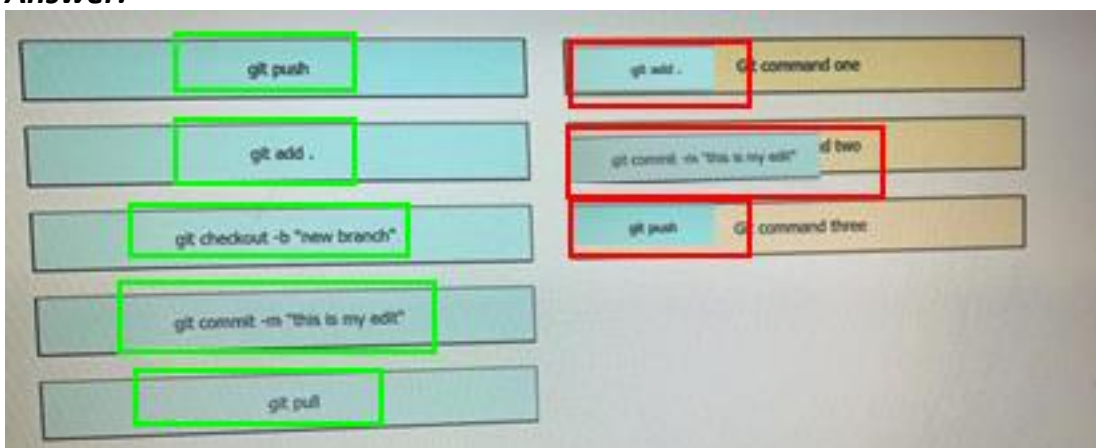

**QUESTION NO: 17**

展示品を参照してください。

```
---
param0: Workflow1
param1:
  list:
    - name: VLAN_ID
      value: '198'
param2: 0
```

添付資料を参照してください。示されているYAMLには、「Workflow1」に等しいオブジェクト「param0」、2つ目のオブジェクト「param1」、そして「list」というオブジェクトを含むオブジェクト「list」、さらに「name」（「VLAN\_ID」に等しい）と「value」（テキスト値「198」に等しい）という2つのオブジェクトの配列、そして最後に「0」に等しい3つ目のオブジェクト「param2」が含まれています。JSONデータ形式では、これに相当するメッセージは何でしょうか？

A.

```
[
  "param0"="Workflow1";
  "param1"=
    "list"=
      ["name"="VLAN_ID";
       "value"="198"]
  "param2"=0
]
```

B.

```
{  
  "param0": "Workflow1";  
  "param1": {  
    "list":  
      [  
        { "name": "VLAN_ID";  
          "value": "198" }  
      ]  
  },  
  "param2": 0  
}
```

C.

```
[  
  "param0": "Workflow1",  
  "param1": {  
    "list":  
      {  
        [ "name": "VLAN_ID",  
          "value": "198" ]  
      }  
  },  
  "param2": 0  
]
```

D.

```
{
  "param0": "Workflow1",
  "param1": {
    "list": [
      {
        "name": "VLAN_ID",
        "value": "198"
      }
    ]
  },
  "param2": 0
}
```

**Answer:** D

Explanation:

The YAML data provided is converted to JSON format. YAML and JSON are both data serialization formats, and the conversion involves retaining the structure and values of the original YAML data. The JSON format uses braces {} and brackets [] to denote objects and arrays, respectively.

### QUESTION NO: 18

The screenshot shows the Cisco Intersight API documentation for the endpoint 'Create Server Profile and Resources'. The main heading is 'Create Server Profile and Resources'. Below it, the specific endpoint is 'POST Create Server VMedia Policy' with the URL 'https://www.intersight.com/api/v1/vmedia/Policies'. A table of headers is provided:

HEADERS	
Accept	application/json
Authorization	Signature {{httpsig}}
Digest	{{computed-digest}}
Date	{{current-date}}
Content-Type	application/json

展示を参照してください。下部のコードを、コードが欠落しているボックスにドラッグアンドドロップして、Cisco SDKを使用してPythonスクリプトを作成します。すべてのオプションが使用されるわけではありません。

```
import sys, json, argparse
from intersight.intersight_api_client import IntersightApiClient
from intersight.apis import asset_device_registration_api, asset_device_claim_api

result = dict(changed=False)

parser = argparse.ArgumentParser()
parser.add_argument('-a', '--api_params', default='intersight_api_params.json')
parser.add_argument('-t', '--target_host', dest='hostname', required=True)
args = parser.parse_args()
with open(args.api_params, 'r') as api_file:
    intersight_api_params = json.load( )
api_instance = IntersightApiClient(
    host=intersight_api_params[''],
    private_key=intersight_api_params['api_private_key_file'],
    api_key_id=intersight_api_params['api_key_id'],
)
api_handle = asset_device_registration_api.AssetDeviceRegistrationApi(api_instance)

kwargs = dict(filter="ConnectionStatus eq 'Connected'")
= api_handle.asset_device_registrations_get(** )
for device in api_result.results:
    if device.device_ip_address[0] == args.hostname:
        api_handle = asset_device_claim_api.AssetDeviceClaimApi(api_instance)
        api_handle.asset_device_claims_moid_delete(moid=device.device_claim.moid)
        result['changed'] = True
        break
```

kwargs

args

api\_file

api\_key

api\_base\_uri

result

api\_result

**Answer:**

```

import sys, json, argparse
from intersight.intersight_api_client import IntersightApiClient
from intersight.apis import asset_device_registration_api, asset_device_claim_api

result = dict(changed=False)

parser = argparse.ArgumentParser()
parser.add_argument('-a', '--api_params', default='intersight_api_params.json')
parser.add_argument('-t', '--target_host', dest='hostname', required=True)
args = parser.parse_args()
with open(args.api_params, 'r') as api_file:
    intersight_api_params = json.load( api_file )
api_instance = IntersightApiClient(
    host=intersight_api_params[' api_base_uri '],
    private_key=intersight_api_params['api_private_key_file'],
    api_key_id=intersight_api_params['api_key_id'],
)
api_handle = asset_device_registration_api.AssetDeviceRegistrationApi(api_instance)

kwargs = dict(filter="ConnectionStatus eq 'Connected'")
result = api_handle.asset_device_registrations_get(** kwargs )
for device in api_result.results:
    if device.device_ip_address[0] == args.hostname:
        api_handle = asset_device_claim_api.AssetDeviceClaimApi(api_instance)
        api_handle.asset_device_claims_moid_delete(moid=device.device_claim.moid)
        result['changed'] = True
        break

```

kwargs

args

api file

api\_key

api\_base\_uri

result

api\_result

**QUESTION NO: 19**

展示を参照してください。

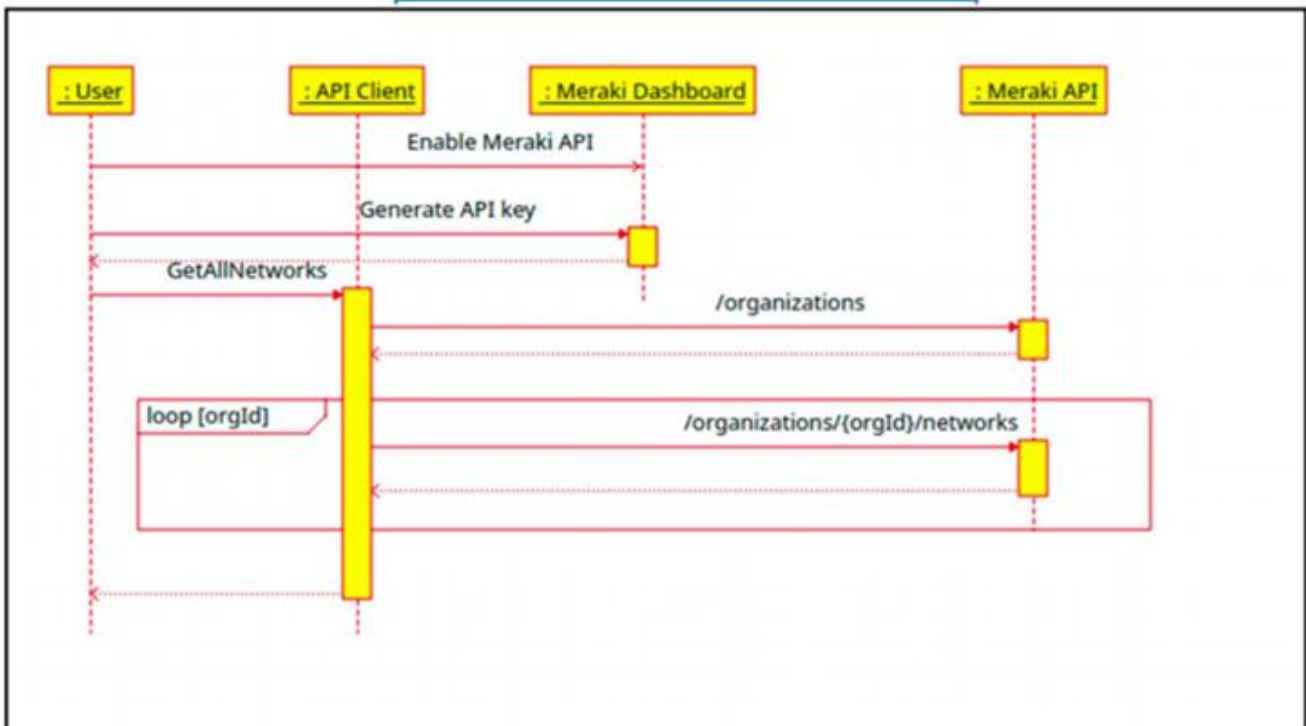

Cisco Meraki API は 2 つの組織を管理します。各組織には、2 つの独立したネットワークが定義されています。API クライアントの GetAllNetwork 関数によって、/organizations/(orgId)/networks エンドポイントへの呼び出しがいくつ並行して実行されますか？

- A. 0
- B. 1
- C. 2
- D. 4

**Answer:** C

Explanation:

The sequence diagram shows the process where the API client first calls the /organizations endpoint to get the list of organization IDs. Then, for each organization, it makes a call to the /organizations/(orgId)/networks endpoint to retrieve the networks for that organization. Since there are two organizations, the GetAllNetworks function will make two parallel calls to the /organizations/(orgId)/networks endpoint, one for each organization.

Reference:

Cisco DevNet Associate Study Guide: Using Cisco Meraki APIs (Chapter 7, Section: Understanding Meraki API Calls and Endpoints).

#### QUESTION NO: 20

バージョン管理システムを使用する利点を説明している2つのステートメントはどれですか。(2つ選択してください。)

- A. 分岐やマージが可能になるため、機能やマスターブランチにマージする前に、さまざまなタスクを個別に処理できます。
- B. 複数のエンジニアが同じコードと構成ファイルに対して作業し、相違点と競合を管理できます。
- C. アプリケーションのビルドとインフラストラクチャのプロビジョニングを自動化するツールを提供します。
- D. 開発者は効果的な単体テストを作成できます。
- E. ユーザーストーリーを追跡し、バックログに割り当てるシステムを提供します。

**Answer:** A,B

Explanation:

A version control system offers several advantages:

**Branching and Merging:** Developers can work on features, bug fixes, or experiments in isolation (branches) without affecting the main codebase. Once the work is completed, it can be merged back into the main branch, facilitating organized and controlled development workflows.

**Collaboration and Conflict Management:** Multiple engineers can work on the same project simultaneously. The version control system tracks changes and helps manage conflicts, ensuring that contributions are properly integrated. These features enhance team collaboration, code integrity, and project organization.

Reference: Cisco DevNet Associate Certification Guide, Chapter 4, Section on Version Control Systems.

**QUESTION NO: 21**

デバイス間で時刻を同期する IP サービスはどれですか？

- A. DNS
- B. NTP
- C. SNMP
- D. NAT

**Answer:** B

Explanation:

Network Time Protocol (NTP) is used to synchronize the clocks of network devices to a common reference time. This is crucial for ensuring accurate time stamps in logs, coordinating time-sensitive operations, and maintaining consistent time across all devices in a network.

NTP: Synchronizes clocks of network devices to ensure they have the same time, which is essential for accurate event logging and coordination.

Other Protocols:

DNS: Resolves domain names to IP addresses.

SNMP: Used for monitoring network devices.

NAT: Translates private IP addresses to public IP addresses.

Reference:

Cisco DevNet Associate Certification Guide

Cisco NTP Overview

**QUESTION NO: 22**

テスト駆動開発の信条は何ですか？

- A. テスト用のドキュメントを書く
- B. 新しいコードブロックを追加した後にテストを作成する
- C. 新しいコードを書く前にテストを書いて実行する
- D. 新しいコードを記述した後にテストを実行する

**Answer:** C

Explanation:

Test-Driven Development (TDD) is a software development approach where tests are written before the code that needs to be tested.

TDD Process:

Write a Test: Start by writing a test for a new feature or functionality.

Run the Test: Run the test, which should fail initially since the code hasn't been written yet.

Write Code: Write the minimum amount of code required to pass the test.

Run Tests Again: Run the tests again to ensure they pass.

Refactor: Refactor the code while ensuring the tests still pass.

Advantages:

Early Bug Detection: Bugs are detected early in the development cycle.

Better Design: Promotes writing cleaner, more modular code.

Documentation: The tests themselves serve as documentation for the code.

Writing and running tests before writing the actual code ensures that the code meets the specified requirements and functions correctly.

Reference:

TDD Overview: Test-Driven Development

### QUESTION NO: 23

クライアント デバイスとホスト

サーバー間の距離が離れると、アプリケーションにどのような影響がありますか？

- A. ジッター
- B. レイテンシ
- C. 接続が失われました
- D. 帯域幅の増加

**Answer:** B

Explanation:

Latency refers to the delay between a client request and a server response. A large distance between a client device and a host server increases the latency due to the time it takes for data to travel over the network.

Latency: The time delay experienced in a system, particularly in networking, where it refers to the time taken for data to travel from the source to the destination.

Impact: High latency can result in slow response times, negatively impacting the performance of applications, especially those requiring real-time interactions.

Reference:

Network Latency Overview: Network Latency

### QUESTION NO: 24

展示を参照してください。

```
API Documentation:

Integrations are how you request permission to invoke the Webex REST API on behalf of another Webex Teams user. To do this in a secure way the API supports the OAuth 2 standard which allows third-party integrations to get a temporary access token for authenticating API calls instead of asking users for their password.

Script:
01 import requests
02
03 base_url = "https://webexapis.com/v1"
04 header = {"Key": "Value"}
05
06 url = "{}/{}".format(base_url, "/teams")
07 print(requests.get(url, headers=header).status code)
```

開発者が Cisco Webex にクエリを実行する Python

スクリプトを作成します。スクリプトを実行すると、401

コードが返されます。トラブルシューティング後、開発者はサービスに権限が不足していることを発見しました。スクリプトの 4 行目のヘッダーのどの変更がコード 200

の原因ですか？

A.

```
header = {"Authentication": "Bearer YOUR_TOKEN"}
```

B.

```
header = {"Authentication Bearer" : "YOUR_TOKEN"}
```

C.

```
header = {"Authorization" : "Bearer YOUR_TOKEN"}
```

D.

```
header = {"Authorization Bearer" : "YOUR_TOKEN"}
```

**Answer: A**

Explanation:

The 401 Unauthorized status code indicates that the request lacks valid authentication credentials. When using OAuth2 for authenticating with the Cisco Webex API, the correct approach is to include a Bearer token in the Authorization header.

Option A:

```
header = {"Authorization": "Bearer YOUR_TOKEN"}
```

This option correctly formats the Authorization header, which is necessary for the Webex API to authenticate the request. The Bearer token is a type of token used by OAuth2 to access protected resources.

Authorization Header: The header must contain the key "Authorization" with the value formatted as "Bearer YOUR\_TOKEN".

Bearer Token: The Bearer keyword followed by a space and the token itself is the correct way to pass the OAuth2 token in the header.

Other Options:

Option B:

Incorrect because it uses "Authentication" instead of "Authorization".

Option C:

Incorrect because it combines Authentication and Bearer incorrectly without a space.

Option D:

Incorrect for the same reason as Option C.

Reference:

Cisco Webex API Authentication

OAuth2 Authorization Header =====

### QUESTION NO: 25

左側の Finesse API の要素を右側の機能の説明にドラッグ アンド ドロップします。

User	Represents a skill group in Unified CCE.
Dialog	Represents the current state of the system.
Media	Represents an agent, supervisor or administrator.
Queue	Represents a group of users.
Team	Represents a call and the participants if the media type is voice.
SystemInfo	Sends client-side logging to the Finesse Server.
ClientLogs	Represents a user's state in a non-voice Media Routing Domain.

**Answer:**

User	Queue	Represents a skill group in Unified CCE.
Dialog	SystemInfo	Represents the current state of the system.
Media	User	Represents an agent, supervisor or administrator.
Queue	Team	Represents a group of users.
Team	Dialog	Represents a call and the participants if the media type is voice.
SystemInfo	ClientLogs	Sends client-side logging to the Finesse Server.
ClientLogs	Media	Represents a user's state in a non-voice Media Routing Domain.

### QUESTION NO: 26

Model-View-Controllerソフトウェア設計パターンの2つの利点は何ですか？  
(2つ選択してください。)

- A. ネットワークの自動化を簡素化
- B. 同じモデルの複数のビューを許可します
- C. CI / CDパイプラインを使用してコードを簡単にデプロイできます
- D. エラー処理の必要性を減らします
- E. コードの責任を分離し、将来の変更を容易にします

**Answer:** B,E

#### Explanation:

The Model-View-Controller (MVC) design pattern is a software architectural pattern that separates an application into three main logical components: the Model, the View, and the Controller. Each of these components is built to handle specific development aspects of an application.

#### Advantages of MVC:

Allows for multiple views of the same model (Option B):

In the MVC architecture, the Model component represents the data and the business logic of the application. It is independent of the user interface. This separation allows the application to have multiple views that can present data in different ways without requiring changes to the underlying data model. For example, the same data can be displayed in a web application, a mobile app, or even a command-line interface, all using the same model.

Separates responsibilities of the code, which makes future modifications easier (Option E):

By separating the application into distinct components (Model, View, Controller), MVC clearly defines the responsibilities of each part. The Model is responsible for data management, the View for the user interface, and the Controller for handling user input and interactions. This separation of concerns makes the application easier to maintain and modify. Future changes can be made to one component without significantly affecting the others. For instance, changes to the user interface can be made in the View without altering the underlying data model or the business logic in the Model.

#### Other Considerations:

Simplifies network automation (Option A): While MVC can be used to create applications that interact with network automation tools, simplifying network automation is not a direct advantage of the MVC pattern itself.

Makes code easier to deploy using CI/CD pipelines (Option C): CI/CD pipelines benefit from modular and well-structured code, but the MVC pattern specifically addresses the organization of code and separation of concerns, rather than deployment processes.

Reduces need for error handling (Option D): Error handling is an essential aspect of any application and is not inherently reduced by the use of MVC. Instead, MVC helps in organizing the code in a way that might make error handling more systematic, but it does not directly reduce the need for it.

The separation of concerns and the ability to have multiple views of the same model are core advantages of using the MVC pattern, making it a powerful design approach for creating scalable and maintainable applications.

#### Reference:

Model-View-Controller (MVC) Architecture

Cisco DevNet Developer Resources

#### **QUESTION NO: 27**

展示を参照してください。

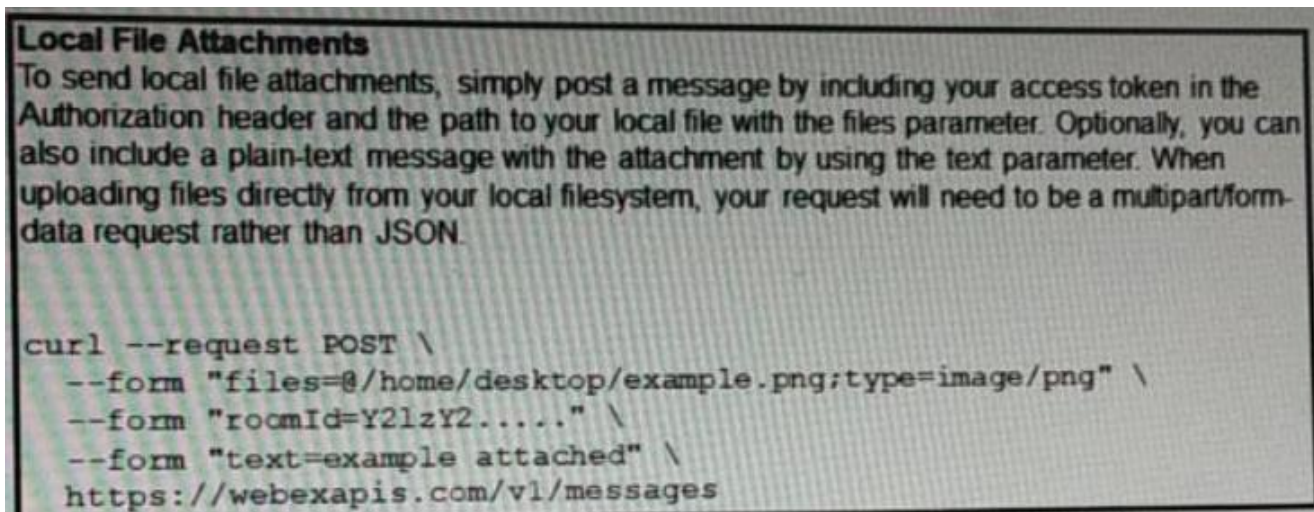

開発者は、REST API を使用してローカルファイルをアップロードする必要があります。開発者はドキュメントに従って情報を収集し、展示の cURL コマンドを使用してリクエストを送信しましたが、エラーコードが返されます。

有効な応答を得るには、どのアクションを実行する必要がありますか？

- A. コンテンツタイプをJSONに変更する
- B. アクセストークンを含む認証ヘッダーを追加します
- C. リクエストコマンドにユーザー名とパスワードの組み合わせを追加します
- D. リクエストメソッドをGETに変更

**Answer:** B

Explanation:

In the provided cURL command, the developer needs to include an authorization header with the access token to authenticate the API request. Without proper authentication, the server will reject the request and return an error code.

#### QUESTION NO: 28

Webhookと対話しているアプリケーションに与えることができる2つの説明はどれですか？ (2つ選択してください。)

- A. プロセッサ
- B. コーデック
- C. リスナー
- D. レシーバー
- E. トランザクションモニター

**Answer:** C,D

Explanation:

In the context of webhooks, an application that interacts with a webhook can be described as a Listener or Receiver:

Listener: The application waits for incoming HTTP POST requests sent by the webhook.

Receiver: The application receives the data payloads from the webhook when certain events occur.

Reference:

Cisco DevNet Associate Certification Guide: Chapter on Webhooks and Event-Driven

Programming.

Webhook documentation and best practices.

### QUESTION NO: 29

展示を参照してください。

```
import requests, sys
from config import user, password

url = "http://restconf.devnet.com:9443/api/running/interfaces"
headers = 
response = requests.put(url, auth=(user, password), headers=headers,
verify=False)
print(response.text)
```

ネットワーク エンジニアは、API を使用してデバイス インターフェイスに関する情報を更新したいと考えています。ネットワーク デバイスは Cisco DevNet Sandbox に導入されており、インターフェイスが稼働しています。コードが欠落しているスニペットにどのコード行を配置する必要がありますか。

- A. {'Content-Type': 'application/yang.data+xml', 'Accept': 'application/yang.data+xml'}
- B. {'Content-Type': 'application/yang.data+yaml', 'Accept': 'application/yang.data+yaml'}
- C. {'Content-Type': 'application/restconf.data+json', 'Accept': 'application/restconf.data+json'}
- D. {'Content-Type': 'application/yang.data=utf8', 'Accept': 'application/restconf.data=utf8'}

**Answer: A**

Explanation:

In this question, the network engineer is using the RESTCONF API to update information about device interfaces. The RESTCONF API uses the YANG data modeling language and can encode data in either XML or JSON format. The appropriate headers must be set to specify the content type and the format in which the data is expected.

RESTCONF API: This API allows network devices to be managed using web-based protocols, and it relies on the YANG data model to represent the configuration data.

Content-Type and Accept headers: These headers define the media type of the resource.

The Content-Type header tells the server what type of data is being sent by the client. The Accept header indicates the type of data that the client can receive from the server.

Option A is the correct answer because it specifies the correct content type and accept headers for using XML with YANG data models in RESTCONF API calls.

Reference:

Cisco DevNet Documentation: RESTCONF API and YANG Models

### QUESTION NO: 30

展示を参照してください。

```

bash-3.2$ curl -H "Content-Type: application/json" -H "Authorization: Bearer
A - Fj2zzykEa09lic9GK2j8LtE1HklH6oRHPQdwlPat60i7ndtHHnWzL2b5PQmG14Kk_B9ei5ISACly7-
NarA-2n9H-tGgt-SxQ39iDejgcs" -i -d "{ \"roomId\":
B - \"Y2geK53sjELknosrC7SwQ5ZGL99pHgiuScB7DfNvUsr8Xx4wDKLiPORcEkryAnM3QmK9LQZsPOG4 \"
, \"text\": \"test2\" }" -X POST https://api.ciscopark.com/v1/messages C
D - HTTP/1.1 200 OK
Via: 1.1 linkerd
Transfer-Encoding: chunked
TrackingID: ROUTER_5E0FE283-63EB-01BB-00ED-806BF1BD00ED
E - Date: Sat, 01 Jan 2020 00:55:31 GMT
Server: Redacted
Content-Type: application/json;charset=UTF-8
Vary: Accept-Encoding
Strict-Transport-Security: max-age=63072000; includedSybDomains; preload

{"id":
YcPjF3aVovyBYcbn7lSdesNkKcgN5t1Exdc6dcnPtl4Va05NfCh9MG17j0tWXQLoIPuoJ73uu7JdoX
q9 ", "roomId":
F - Y2geK53sjELknosrC7SwQ5ZGL99pHgiuScB7DfNvUsr8Xx4wDKLiPORcEkryAnM3QmK9LQZsPOG4
", " roomType": "group", "text": "test2", "personId":
YcgYzL6XgtyfW81XXwqfKf7whfj23KuqWt4kLWkbb3JwEJBlVMZOkIvyDdFoppb0einNj111FcMyy5
wD", "personEmail": "user@webex.com", "created": "2020-01-01T00:55:32.492Z"}
bash-3.2$

```

左側の記述子を右側の API リクエストとレスポンスの適切な部分にドラッグ アンド ドロップします。

Response Headers	A
HTTP Request	B
HTTP Response	C
Request Payload	D
Request Headers	E
Response Payload	F

**Answer:**

**QUESTION NO: 31**

Cisco DevNetリソースはどの2つですか？（2つ選択してください。）

- A.TACサポート
- B.Bitbucket
- C.サンドボックス
- D.ソフトウェア調査
- E.APIドキュメント

**Answer:** C,E

Reference:

Cisco DevNet provides several resources to help developers and network engineers learn, code, and manage their networks more effectively:

**Sandbox:** Cisco DevNet Sandboxes offer preconfigured environments to develop, test, and explore various Cisco technologies and APIs without needing physical hardware. These sandboxes are available 24/7 and provide instant access to a wide range of Cisco solutions.

**API Documentation:** DevNet provides comprehensive API documentation for Cisco products and solutions, allowing developers to understand and use Cisco APIs effectively. This documentation includes detailed information about endpoints, parameters, request/response formats, and example code.

Cisco DevNet Associate Certification Guide: Chapter on Cisco DevNet Resources and Tools.  
Cisco DevNet Portal: Sandbox and API Documentation.

**QUESTION NO: 32**

展示を参照してください。

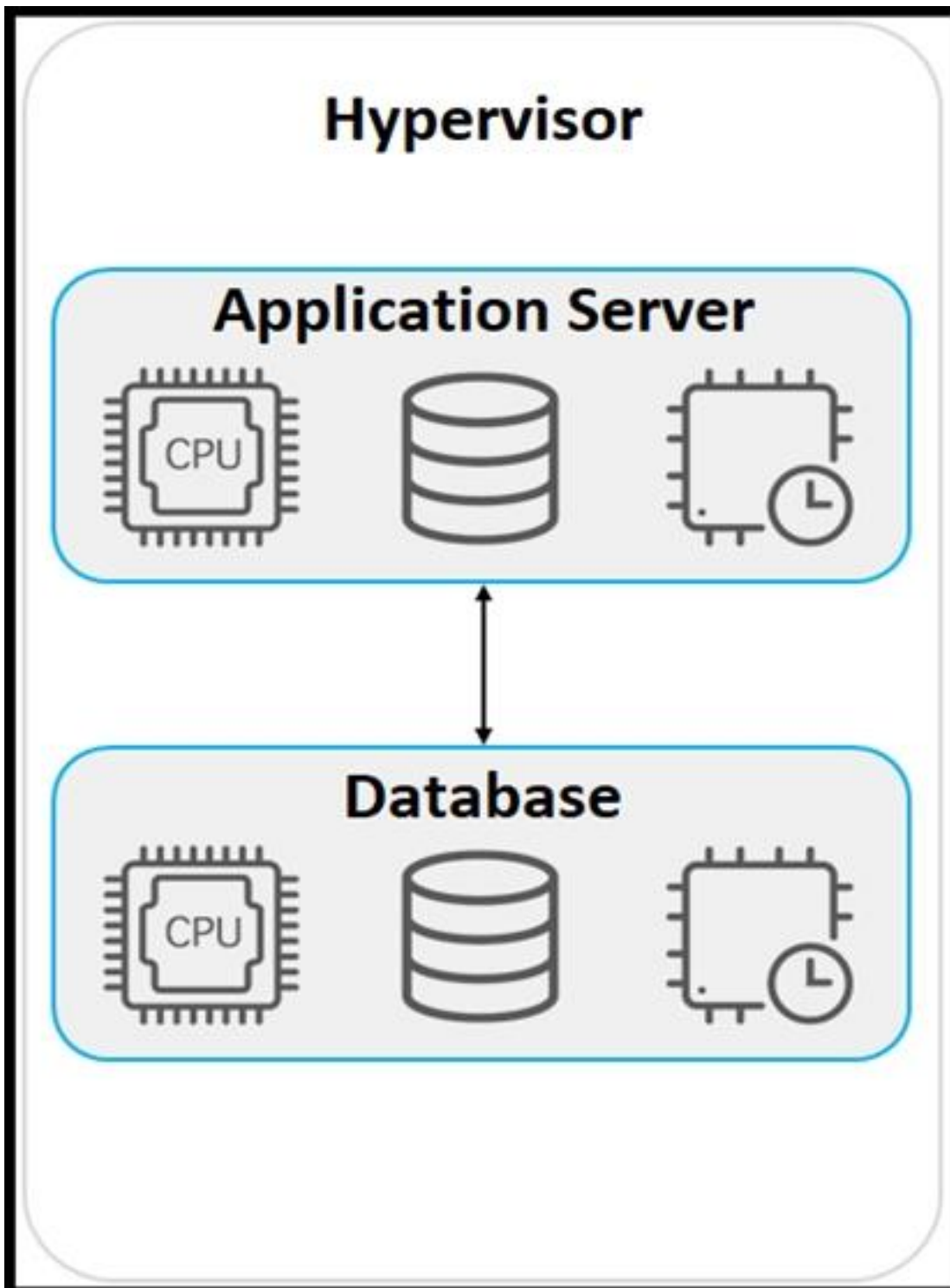

アプリケーションは、他のアプリケーションがインストールされているサーバーに展開する必要があります。サーバーリソースは、展開要件に基づいて割り当てられます。各アプリケーションの OS は独立している必要があります。どのタイプの展開が使用されますか？

- A. ハイブリッド
- B. 仮想マシン
- C. コンテナ
- D. ベアメタル

**Answer:** B

**Explanation:**

The exhibit shows an architecture where each application runs in its own isolated environment with its own OS. This setup is typical of virtual machines (VMs), where multiple VMs can run on a single physical server managed by a hypervisor.

Isolation: VMs provide complete isolation between applications, including independent operating systems.

Resource Allocation: Resources such as CPU, memory, and storage can be allocated based on deployment requirements.

Option B is correct as the type of deployment used is virtual machines.

**Reference:**

Cisco DevNet Documentation: Virtual Machines and Hypervisors

**QUESTION NO: 33**

Cisco Finesse の 2 つの主要な機能は何ですか? (2 つ選択してください。)

- A. Finesse には、カスタム ガジェットの開発を可能にする RPC API が含まれています。
- B. エージェントは、クライアントマシンに何かをインストールしたり設定したりすることなく、ブラウザから Finesse にアクセスします。
- C. Finesse はテレメトリデータを自動的に収集します
- D. OpenDNS ユーティリティは事前に設定されており、Finesse ですぐに使用できます。
- E. ガジェット コンテナは、単一のユーザーインターフェイスでシームレスなエクスペリエンスを提供します。

**Answer:** B,E

**Explanation:**

Cisco Finesse offers several capabilities:

Browser Access: Agents can access Finesse directly from a browser, eliminating the need for any client-side installation or configuration. This simplifies deployment and maintenance.

Gadget Containers: Finesse provides a single user interface that integrates multiple gadget containers, allowing for a seamless and unified experience.

**QUESTION NO: 34**

ネットワーク環境におけるイーサネット スイッチの機能は何ですか?

- A. IP アドレスに基づいて、あるポートから別のポートにフレームを切り替える
- B. MAC アドレスに基づいて、あるポートから別のポートにフレームを切り替える
- C. 接続されたホストに IP アドレスを提供する
- D. 不要なトラフィックをブロックする

**Answer:** B

**Explanation:**

An Ethernet switch operates at the Data Link layer (Layer 2) of the OSI model. Its primary function is to forward frames between devices based on their MAC (Media Access Control) addresses. When a frame arrives at the switch, the switch reads the destination MAC address and forwards the frame to the appropriate port that connects to the device with that MAC address.

MAC Address Table: Switches maintain a MAC address table that maps each MAC address

to a specific port. This table is built dynamically as the switch learns the MAC addresses of devices connected to its ports.

Frame Switching: By using the MAC address table, the switch can efficiently switch frames only to the destination port, which reduces unnecessary traffic on other ports and improves network performance.

Reference:

Cisco DevNet Associate Certification Guide

Cisco Ethernet Switch Operation

### QUESTION NO: 35

MACアドレスの目的は何ですか？

A.LAN内のルーターを一意に識別するため

B.LAN内のネットワークインターフェイスを一意に識別するため

C.インターネット上のデバイスを一意に識別するため

D.LAN内のスイッチを一意に識別する

**Answer:** B

Explanation:

A MAC (Media Access Control) address is a unique identifier assigned to a network interface card (NIC) for communications at the data link layer of a network segment. MAC addresses are used within local area networks (LANs) to ensure that data packets are delivered to the correct hardware device. Every network interface on a device, such as a computer, router, or switch, has a unique MAC address.